

# User manual

## Washer extractor

**WE170P**  
**PNC 914535307**



**Electrolux**  
PROFESSIONAL



# Contents

---

## Contents

1	Safety Information .....	5
1.1	Children and vulnerable people safety .....	5
1.2	Installation.....	6
1.3	Electrical connection .....	6
1.4	Water connection .....	7
1.5	Use.....	7
1.6	Care and cleaning.....	7
1.7	Internal lighting .....	7
1.8	Service .....	8
1.9	Disposal.....	8
2	Warranty terms and exclusions.....	9
3	Product description.....	10
4	Accessories .....	11
4.1	Stacking kit.....	12
4.2	Pedestal with the drawer .....	12
4.3	Anchoring kit .....	12
4.4	External detergent dispenser .....	13
5	Control panel .....	14
5.1	Display.....	15
6	Before first use.....	16
7	Programs.....	17
8	Options.....	18
8.1	Pre rinse .....	18
8.2	Pre wash.....	18
8.3	Extra rinse.....	18
8.4	Spin time.....	18
8.5	No softener .....	18
8.6	Delay start.....	18
9	Settings .....	19
9.1	Acoustic signals.....	19
9.2	Child Lock .....	19
9.3	Permanent Extra Rinse .....	19
10	Daily use .....	20
10.1	Loading the laundry .....	20
10.2	Installing the flap for liquid detergent .....	20
10.3	Using detergent and additives.....	21
10.4	Detergent compartments.....	21
10.5	Liquid or powder detergent .....	21
10.6	Activating the appliance.....	21
10.7	Setting a program .....	22
10.8	Starting a program .....	22
10.9	Starting a program with the delay start.....	22
10.10	Cancelling the delay start .....	22
10.11	Interrupting a program and changing the options .....	22
10.12	Cancelling a running program .....	23
10.13	At the end of the program .....	23
10.14	AUTO OFF option .....	23
11	Hints and tips .....	24
11.1	The laundry load .....	24
11.2	Stubborn stains.....	24
11.3	Detergent type and quantity.....	25
11.4	Ecological hints.....	25
11.5	Water hardness .....	25
12	Care and cleaning .....	26
12.1	Periodic cleaning schedule .....	26
12.2	Removing foreign objects .....	26
12.3	External cleaning .....	26
12.4	Descaling .....	26
12.5	Maintenance wash.....	26
12.6	Door seal .....	27

# Contents

---

12.7	Cleaning the drum.....	27
12.8	Cleaning the detergent dispenser.....	27
12.9	Cleaning the drain filter.....	28
12.10	Cleaning the inlet hoses and the valve filters.....	28
12.11	Emergency drain.....	28
12.12	Frost precautions.....	29
13	Trouble shooting.....	30
13.1	Alarm Codes and Possible failures.....	30
14	Emergency door opening.....	32
15	Technical data.....	33
15.1	Electrical connection.....	33
16	Disposal information.....	34
16.1	Disposal of appliance at end of life.....	34
16.2	Disposal of packing.....	34

The manufacturer reserves the right to make changes to design and component specifications.

## 1 Safety Information

Before beginning the installation and use of this appliance, carefully read the supplied instructions. The manufacturer is not responsible for any injuries or damage that are the result of incorrect installation or usage. Always keep the instructions in a safe and accessible location for future reference.



Read the instructions before using the machine

### 1.1 Children and vulnerable people safety

- This appliance can be used by children aged from 8 years and above and persons with reduced physical, sensory or mental capabilities or lack of experience and knowledge if they have been given supervision or instruction concerning the use of the appliance in a safe way and understand the hazards involved.
- Children between 3 and 8 years of age and persons with very extensive and complex disabilities shall be kept away from the appliance unless continuously supervised.
- Children of less than 3 years of age should be kept away from the appliance unless continuously supervised.
- Do not let children play with the appliance.
- Keep all packaging away from children and dispose of it appropriately.
- Keep detergents away from children.
- Keep children and pets away from the appliance when the door is open.
- If the appliance has a child safety device, it should be activated.
- Children shall not carry out cleaning and user maintenance of the appliance without supervision.

## **1.2 Installation**

- This appliance is for household and commercial use.
- Follow the installation instructions supplied with the appliance.
- Remove all the packaging and the transit bolts.
- Keep the transit bolts in a safe place. If the appliance is to be moved in the future they must be reattached to lock the drum to prevent an internal damage.
- Always take care when moving the appliance as it is heavy. Always use safety gloves and enclosed footwear.
- Do not install or use a damaged appliance.
- Make sure that the appliance is stable during transportation.
- Make sure that the appliance is disconnected from the electricity supply during installation, maintenance and repairs and cannot be reconnected until all work has been carried out.
- Do not install or use the appliance where the temperature can be less than 0°C or where it is exposed to the weather.
- Make sure that all health and safety regulations are obeyed when the appliance is installed in a commercial/public environment.
- Do not install the appliance in a moving platform (e.g. on a ship).
- The floor area on which the appliance is to be installed must be flat, stable, heat resistant and clean.
- Make sure that there is air circulation between the appliance and the floor.
- The ventilation openings in the base (if applicable) must not be obstructed by a carpet.
- Adjust the feet to have the necessary space between the appliance and the carpet.
- Do not install the appliance behind a lockable door, a sliding door or a door with a hinge on the opposite side, that would prevent the appliance door from being fully open.
- Do not put a container to collect possible water leakage under the appliance. Contact the Authorized Service Centre to ensure which accessories can be used.

## **1.3 Electrical connection**

- The appliance must be correctly earthed. The manufacturer is not responsible for the consequences of an inadequate earthing system.
- Always use a correctly installed shockproof socket.
- Make sure that the parameters on the rating plate are compatible with the electrical ratings of the mains power supply.
- Do not use multi-plug adapters and extension cables.
- Make sure not to cause damage to the mains plug and to the mains cable.
- If the supply cord is damaged, it must be replaced by the manufacturer, its Authorized Service Centre or similarly qualified persons to avoid an electrical hazard.
- Connect the mains plug to the mains socket only at the end of the installation. Make sure that there is access to the mains plug after the installation.
- Do not touch the mains cable or the mains plug with wet hands.
- Do not pull the mains cable to disconnect the appliance. Always pull the mains plug.

#### 1.4 Water connection

- Do not cause damage to the water hoses.
- The appliance is to be connected to the water mains using the new supplied hose-sets. Old hose sets must not be reused.
- Before connection to new pipes, pipes not used for a long time, where repair work has been carried out or new devices fitted (water meters, etc.), let the water flow until it is clean and clear.
- The operating water pressure (minimum and maximum) must be between 0.5 bar (0.05 MPa) and 10 bar (1.0 MPa).
- Ensure that there are no visible water leaks during and after the first use of the appliance.

#### 1.5 Use

- Do not change the specification of the appliance.
- Obey the safety instructions on the detergent packaging.
- Obey the maximum load volume of 8.0 kg (please refer to the “Programs” section).
- Do not put flammable products or items that are wet with flammable products in, near or on the appliance.
- Make sure that you remove all metal objects from the laundry.
- Do not touch the glass of the door while a program operates. The glass can be hot.

#### 1.6 Care and cleaning

- Before maintenance, deactivate the appliance and disconnect the mains plug from the mains socket.
- Do not use water spray and steam to clean the appliance.
- Clean the appliance with a moist soft cloth. Use only neutral detergents. Do not use abrasive products, abrasive cleaning pads, solvents or metal objects.

#### 1.7 Internal lighting



#### Warning



Risk of injury.

- Visible LED radiation, do not look directly into the beam.
- To replace the internal lighting, contact the Authorized Service Centre.

**1.8 Service**

- To repair the appliance, contact the Authorized Service Centre.
- Only authorized spare parts, accessories and consumables shall be used.
- Please note that self-repair or non-professional repair can have safety consequences and might void the guarantee.
- Concerning the lamp(s) inside this product and spare part lamps sold separately: These lamps are intended to withstand extreme physical conditions in household appliances, such as temperature, vibration, humidity, or are intended to signal information about the operational status of the appliance. They are not intended to be used in other applications and are not suitable for household room illumination.

**1.9 Disposal**

- Disconnect the appliance from the mains electrical and water supplies.
- Cut off the mains electrical cable close to the appliance and dispose of it.
- Remove the door catch to prevent children or pets from becoming trapped in the drum.



## 2 Warranty terms and exclusions

If the purchase of this product includes warranty coverage, warranty is provided in line with local regulations and subject to the product being installed and used for the purposes as designed, and as described within the appropriate equipment documentation.

Warranty will be applicable where the customer has used only genuine spare parts and has performed maintenance in accordance with Electrolux Professional user and maintenance documentation made available in paper or electronic format.

Electrolux Professional strongly recommends using Electrolux Professional approved cleaning, rinse and descaling agents to obtain optimal results and maintain product efficiency over time.

The Electrolux Professional warranty does not cover:

- service trips cost to deliver and pick up the product;
- installation;
- training on how to use/operate;
- replacement (and/or supply) of wear and tear parts unless resulting from defects in materials or workmanship reported within one (1) week from the failure;
- correction of external wiring;
- correction of unauthorized repairs as well as any damages, failures and inefficiencies caused by and/or resulting from;
  - insufficient and/or abnormal capacity of the electrical systems (current/voltage/frequency, including spikes and/or outages);
  - inadequate or interrupted water supply, steam, air, gas (including impurities and/or other that does not comply with the technical requirements for each appliance);
  - plumbing parts, components or consumable cleaning products that are not approved by the manufacturer;
  - customer's negligence, misuse, abuse and/or non-compliance with the use and care instructions detailed within the appropriate equipment documentation;
  - improper or poor: installation, repair, maintenance (including tampering, modifications and repairs carried out by third parties not authorized third parties) and modification of safety systems;
  - Use of non-original components (e.g.: consumables, wear and tear, or spare parts);
  - environment conditions provoking thermal (e.g. overheating/freezing) or chemical (e.g. corrosion/oxidation) stress;
  - foreign objects placed in- or connected to- the product;
  - accidents or force majeure;
  - transportation and handling, including scratches, dents, chips, and/or other damage to the finish of the product, unless such damage results from defects in materials or workmanship and is reported within one (1) week of delivery unless otherwise agreed;
- product with original serial numbers that have been removed, altered or cannot be readily determined;
- replacement of light bulbs, filters or any consumable parts;
- any accessories and software not approved or specified by Electrolux Professional.

Warranty does not include scheduled maintenance activities (including the parts required for it) or the supply of cleaning agents unless specifically covered within any local agreement, subject to local terms and conditions.

Check on Electrolux Professional website the list of authorized customer care.

### 3 Product description

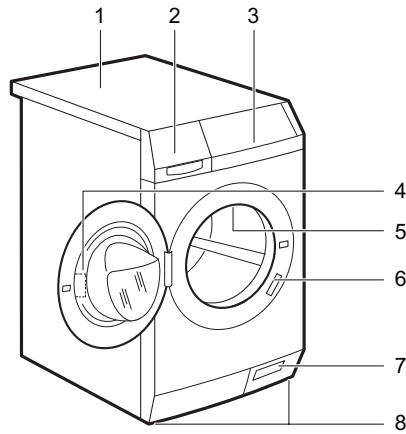

fig.X02928

1	Worktop
2	Detergent dispenser
3	Control panel
4	Door handle
5	Internal light
6	Rating plate
7	Drain pump filter and emergency door opening
8	Feet for levelling the appliance

The rating plate reports the model name (A), product number (B), electrical ratings (C) and serial number (D).

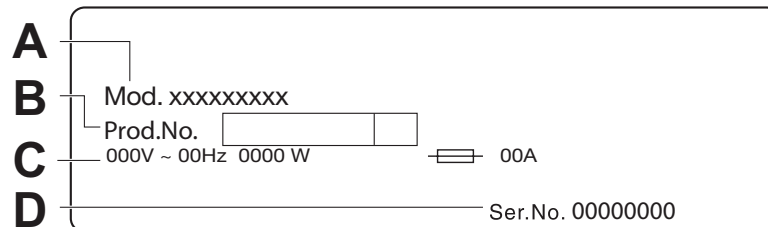

fig.X02929

## 4 Accessories

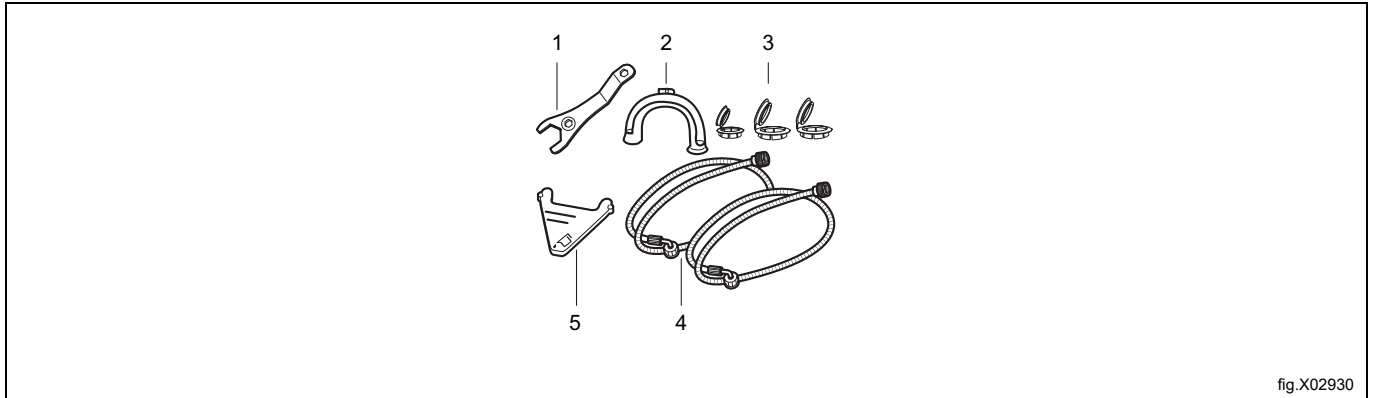

fig.X02930

1	<b>Spanner</b> To remove the transit bolts.
2	<b>Plastic hose guide</b> To connect the drain hose on the edge of a sink.
3	<b>Plastic caps</b> To close the holes on the rear side of the cabinet after the removal of the transit bolts.
4	<b>Inlet hoses</b> To connect the appliance to the cold and hot water tap: blue cap hose for cold water and red cap hose for hot water.
5	<b>Flap for liquid detergent</b> To slow down the liquid detergent flow.

### 4.1 Stacking kit

It is available from your authorized vendor.

Stacking kit can be used only with the tumble dryers specified in the leaflet. See the leaflet attached. Read carefully the instructions supplied with the accessory.

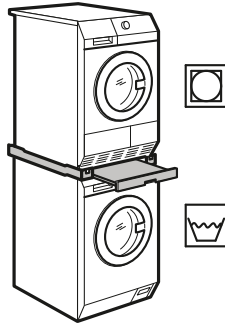

fig.X02238

### 4.2 Pedestal with the drawer

It is available from your authorized vendor.

To put the appliance higher at the level what helps to easy load and remove the laundry.

The drawer can be used for laundry storage e.g. : towels, cleaning products and more.

Read carefully the instructions supplied with the accessory.

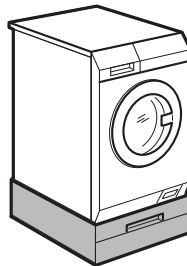

fig.X02240A

### 4.3 Anchoring kit

It is available from your authorized vendor.

If you install the appliance on a concrete base, please make sure to order the correct anchoring kit.

Read carefully the instructions supplied with the accessory.

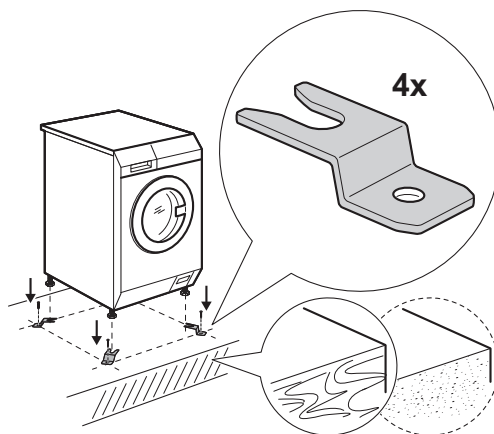

fig.X02931

#### 4.4 External detergent dispenser

It is available from your authorized vendor.

The liquid detergent can be loaded automatically from an external dispenser.

Read carefully the instructions supplied with the accessory.

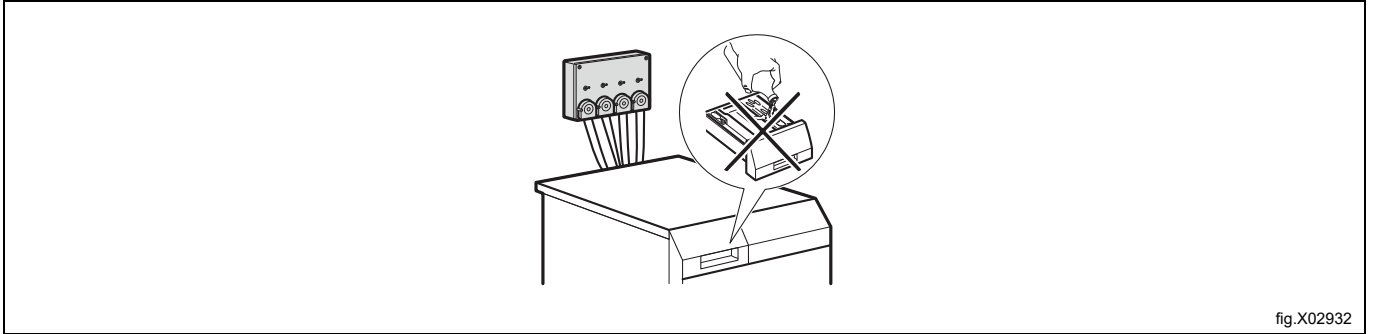

fig.X02932

## 5 Control panel

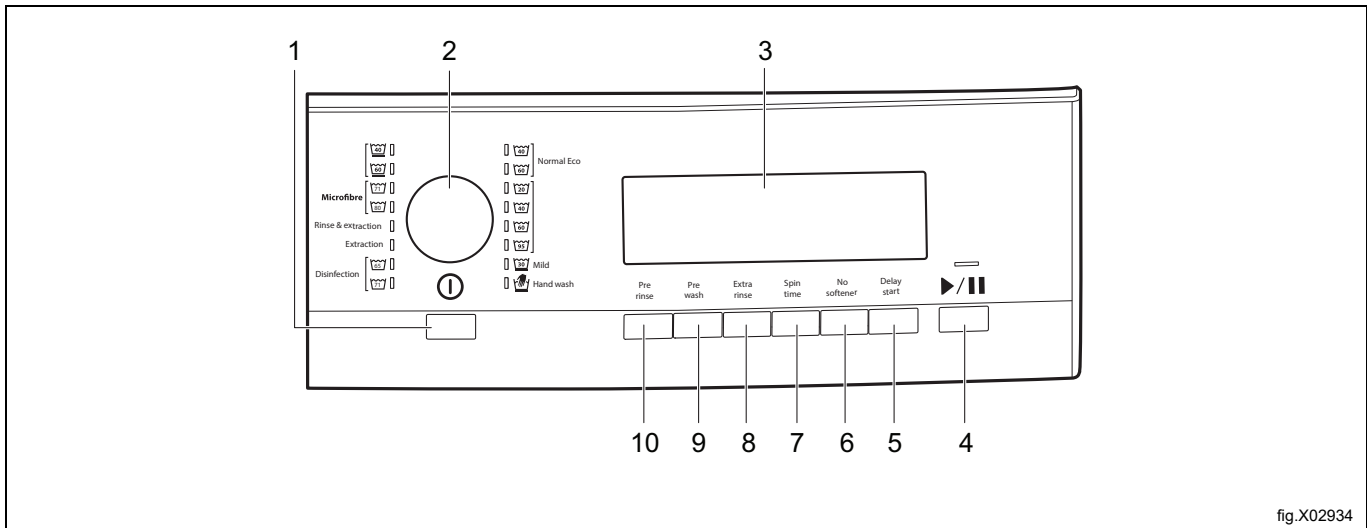

fig.X02934

1	Auto Off button ⓘ
2	Program knob
3	Display
4	Start/Pause button ▶
5	Delay start button
6	No softener button
7	Spin time button
8	Extra rinse button
9	Pre wash button
10	Pre rinse button

5.1 Display

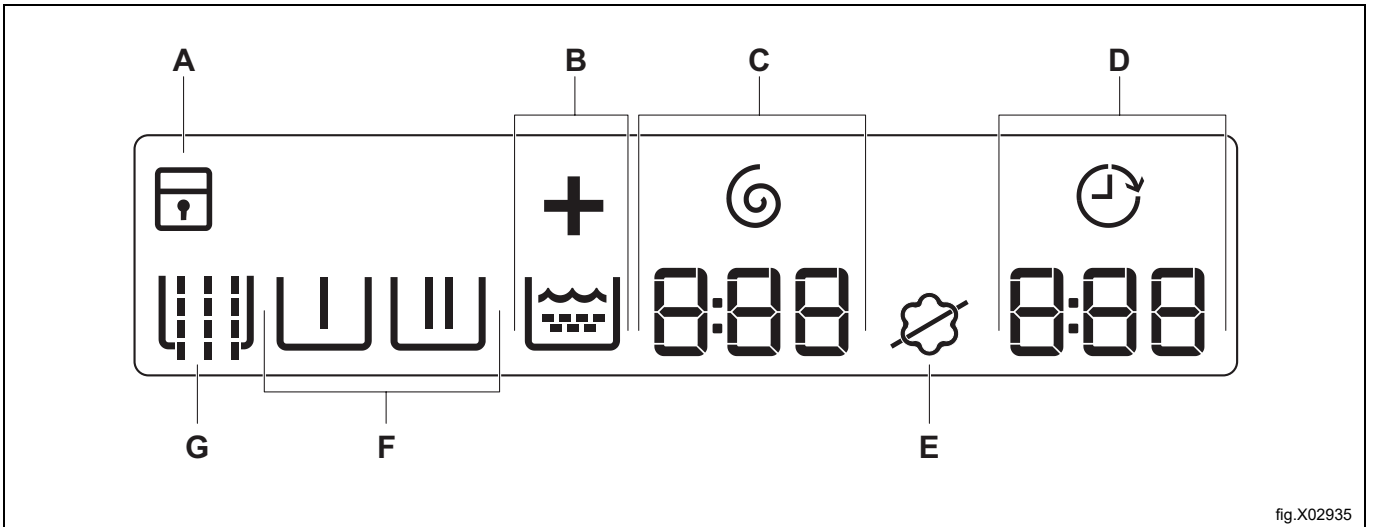

fig.X02935

Symbol on the display	Symbol description	
A		The child safety lock is activated.
		The child safety lock is deactivated.
B		Extra rinse symbol.  is the symbol indicating the rinse phase and “ + ” lights up when the Extra rinse is selected.
C		Spin time indicator and symbol. The digit indicates minutes and seconds.
D		Delay start indicator.
		Program time When the program starts, the program time decreases with steps of 1 minute. The digit indicates hours and minutes.
		Delay start When you press the delay start button, the display shows the delay start time.
		Alarm codes If the appliance has a malfunction, the display shows alarm codes. Please refer to the section “Troubleshooting”.
		The display shows this message for some seconds when: <ul style="list-style-type: none"> <li>You cannot set a function with the program.</li> <li>You try to change the program while it operates.</li> </ul>
		When the program is completed.
E		Softener symbol: the appliance does load softener normally.
		No softener symbol: the appliance doesn't load softener.
F		The phase symbols When a program is set, all the symbols of the phases related to the program come on. When the program starts, only the symbol of the phase in operation lashes. When the phase is completed, the symbol remains steady lighted up.
		Pre wash phase
		Washing phase
		Rinse phase
G		Spin phase
		Pre rinse symbol

















## 6 Before first use

1. Make sure that all transit bolts are removed.
2. Make sure that the electrical and water connection are available.
3. Put 2 liters of water in the detergent compartment for washing phase. This activates the drain system.
4. Set and start a program for cotton at the highest temperature without detergent and laundry. This removes all possible dirt from the drum and the tub.



## 7 Programs

The following table shows the available programs and a short description of those:

Program Temperature range <sup>1</sup>	Maximum load <sup>2</sup>	Reference spin speed	Spin Time	Description
Normal Eco 	4.0 kg	1400 rpm	540 – 5 seconds	White cotton and fast-coloured cotton. Normally soiled items. The energy consumption decreases and the time of the program is extended, ensuring good washing results.
Normal Eco <sup>3</sup> 	8.0 kg	1400 rpm	540 – 5 seconds	White cotton and fast-coloured cotton. Normally soiled items. The energy consumption decreases and the time of the program is extended, ensuring good washing results.
Cottons   	8.0 kg	1400 rpm	360 – 5 seconds	White cottons <sup>4</sup> Normally and lightly soiled items.
Cottons   	8.0 kg	1400 rpm	360 – 5 seconds	Coloured cottons <sup>5</sup> Normally and lightly soiled items.
Mild 	4.0 kg	1200 rpm	120 – 5 seconds	Delicate fabrics such as acrylics, viscose and mixed fabrics requiring gentler washing. Normally and lightly soiled items.
Hand wash  	2.0 kg	1200 rpm	120 – 5 seconds	Machine washable wool, hand washable wool and other fabrics with “hand washing” care symbol. <sup>6</sup>
Synthetics  	4.0 kg	1200 rpm	120 – 5 seconds	Synthetic items or mixed fabric items. Normally soiled items.
Microfibre  	8.0 kg	1400 rpm	240 – 5 seconds	Program for mops, work wear and special program for microfibres. The program performs an automatic pre rinse phase.
Rinse & extraction	8.0 kg	1400 rpm	360 – 5 seconds	To rinse and spin the laundry. All fabrics, except woollens and very delicate fabrics. Reduce the spin speed accordingly to the type of laundry.
Spin	8.0 kg	1400 rpm	360 – 5 seconds	All fabrics, except woollens and delicate fabrics. To spin the laundry and to drain the water in the drum.
Disinfection  	8.0 kg	1400 rpm	360 – 5 seconds	This program removes dust mites and similar micro-organisms. The program performs an automatic pre wash phase.

1. If connected, hot water is loaded only in the program Normal Eco, Cottons, Synthetics, Microfibre and Disinfection when the set temperature is 40°C or higher.
2. For an optimal result, the maximum load indicated for each program is recommended.
3. The program Normal Eco at 60°C is recommended for a full load of cotton and is the water and energy rating label program in accordance with AS/NZS2040 and AS/NZS6400.
4. A detergent with bleach should be used.
5. A detergent without bleach should be used.
6. During this cycle the drum rotates slowly to ensure a gentle wash. It can seem that the drum doesn't rotate or doesn't rotate properly, but this is normal for this program.

### Program options compatibility

Program	Pre rinse	Pre wash	Extra rinse	Spin time	No softener	Delay start
Normal Eco	X	X	X	X	X	X
Cottons	X	X	X	X	X	X
Mild 30°C	X	X	X	X	X	X
Hand wash	X	-	-	X	X	X
Synthetics 40°-60°C	X	X	X	X	X	X
Microfibre	X <sup>1</sup>	-	X	X	X	X
Rinse & extraction	-	-	X	X	-	X
Spin	-	-	-	X	-	X
Disinfection	X	X <sup>1</sup>	X	X	X	X

1. This option is automatically performed and cannot be removed from the program.

## 8 Options

### 8.1 Pre rinse

Press this button to add a pre rinse phase without detergent before washing.

The display shows the related indicator 

### 8.2 Pre wash

With this option you can add a prewash phase to a program.

Use this option for heavy soil.

When you set this option the program duration increases.

The display shows the related indicator 

### 8.3 Extra rinse

With this option you can add some rinses to a program.

Use this option for persons allergic to detergents and in areas where the water is soft.

The display shows the related indicator 

### 8.4 Spin time

By pressing this button you can decrease the spin time. Once you reach the minimum time (5 seconds) it restarts from the maximum time again.

The display shows the related indicator 

### 8.5 No softener

Press this button to exclude the softener load.

The display shows the related indicator 

Press this button again, the softener is loaded normally.

The display shows the related indicator 

### 8.6 Delay start

With this option you can delay the start of a program from 30 minutes to 24 hours.

The display shows the related indicator 

## 9 Settings

### 9.1 Acoustic signals

The acoustic signals operate when:

- You activate the appliance.
- You select a program.
- You deactivate the appliance.
- You press the buttons.
- The program is completed.
- The appliance has a malfunction.



To deactivate/activate the acoustic signals, press  and  at the same time for 6 seconds.

If you deactivate the acoustic signals, they will continue to operate when the appliance has a malfunction.



### 9.2 Child Lock

With this option you can prevent that the children play with the control panel.

To activate/deactivate this option, press the  and  buttons simultaneously until the related indicator comes on in the display:

- Child lock activated: 
- Child lock deactivated: 

You can activate this option:

- After you press the  button, the options and the program knob are locked.
- Before you press the  button, the appliance cannot start.

If the appliance is coin operated, the child lock activates automatically 5 minutes after the program start.

### 9.3 Permanent Extra Rinse

With this option you can permanently have an extra rinse when you set a new program.

- To activate/deactivate this option press  and  at the same time until the indicator  comes on/goes off.

## 10 Daily use



### Warning



Please refer to the “Safety information” sections.

### 10.1 Loading the laundry

1. Pull the handle to open the door.
2. Shake the items before you put them in the appliance.
3. Put the laundry in the drum, one item at a time. Make sure not to put too much laundry in the drum.
4. Close the door.



### Caution



Make sure that no laundry stays between the seal and the door. There is a risk of water leakage or damage to the laundry.

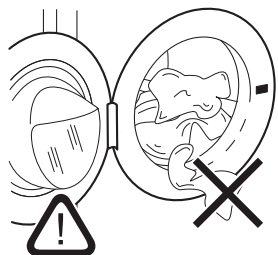



fig.X03521

### 10.2 Installing the flap for liquid detergent

- Open the detergent dispenser.
- Install the flap for liquid detergent in the compartment: 

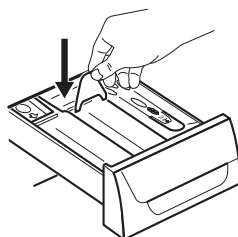

fig.X03522

### 10.3 Using detergent and additives

1. Measure out the detergent and the fabric conditioner.
2. Put the detergent and the fabric conditioner into the compartments.
3. Carefully close the detergent dispenser.

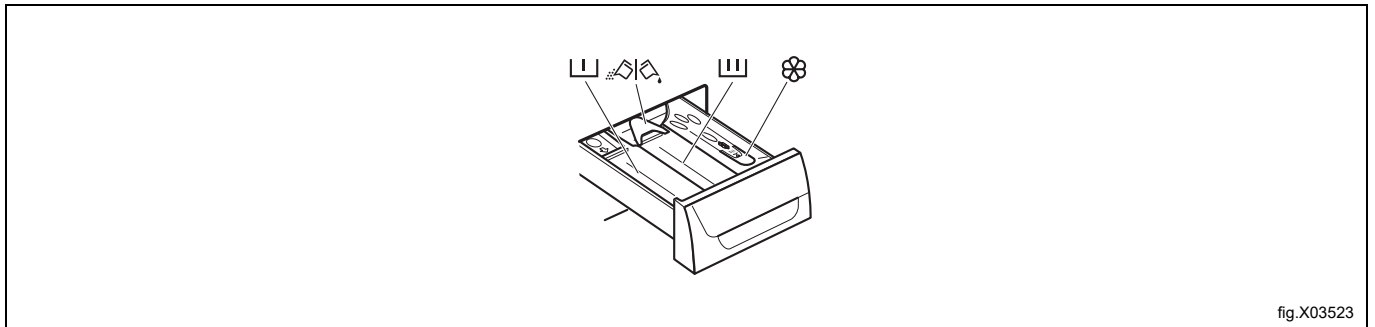

fig.X03523

### 10.4 Detergent compartments

Caution

Use only specified detergents for washer extractors.

Always obey the instructions that you find on the packaging of the detergent products.

	Detergent compartment for prewash phase.
	Detergent compartment for washing phase.
	Compartment for liquid additives (fabric conditioner, starch).
	Flap for powder or liquid detergent.

### 10.5 Liquid or powder detergent

- Position A for powder detergent (factory setting).
- Position B for liquid detergent.

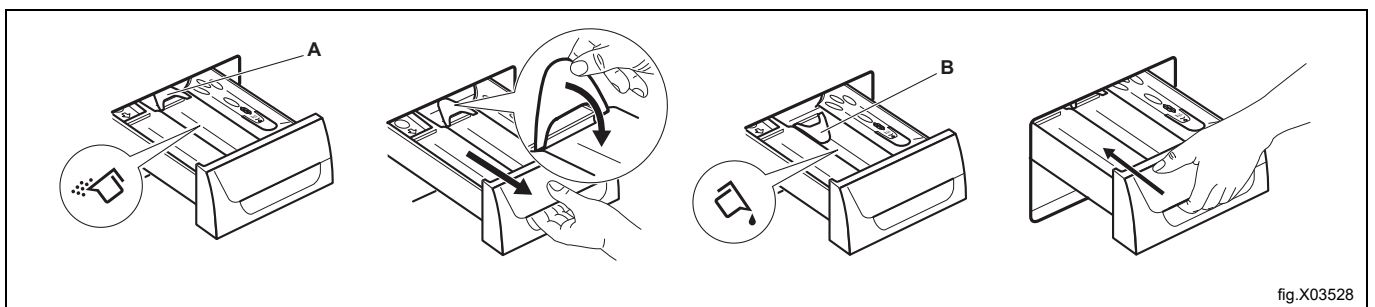

fig.X03528

When you use the liquid detergent:

- Do not use gelatinous or thick liquid detergents.
- Do not put more liquid than the maximum level.
- Do not set the prewash phase.
- Do not set the delay start.

### 10.6 Activating the appliance

Press the button to activate the appliance. A tune sounds (if it is activated).

## 10.7 Setting a program

1. Turn the program knob and set the program:
  - The related program indicator comes on. A tune sounds (if it is activated).
  - The indicator of Start/Pause button flashes.
  - The display shows the program duration and the indicators of the program phases.
2. If necessary, change the spin time and add the available options. When you activate an option, the indicator of the set option comes on.

If you set something incorrect, the display shows the message **Err**.

## 10.8 Starting a program

Press the  button.

- The indicator of the  button stops flashing and stays on.
- The indicator of the running phase starts flashing on the display.
- The program starts and the door locks.
- The drain pump can operate for a short time when the appliance fills water.

After approximately 15 minutes from the start of the program:

- The appliance can adjust the program duration automatically depending on the laundry load.
- The display shows the new time to end.

## 10.9 Starting a program with the delay start

1. Press the “Delay start” button repeatedly until the display shows the delay you want to set.

The related indicator comes on the display .

2. Press the “Start/Pause” button:

- The appliance starts the countdown.
- When the countdown is completed, the program starts automatically.

You can cancel or change the set of the delay start before you press the “Start/Pause” button. To cancel the delay start:

- Press the “Start/Pause” button to set the appliance to pause.
- Press the “Delay start” button until the display shows .
- Press the “Start/Pause” button again to start the program immediately.

## 10.10 Cancelling the delay start

To cancel the delay start:

1. Press the “Start/Pause” button to set the appliance to pause.  
The related indicator flashes.
2. Press the “Delay start” button repeatedly until the display shows .
3. Press the “Start/Pause” button again to start the program immediately.

## 10.11 Interrupting a program and changing the options

You can change only some options before they operate.

1. Press the “Start/Pause” button. The indicator flashes.
2. Change the options.
3. Press the “Start/Pause” button again. The program continues.

If the appliance is coin operated, you can interrupt a program only 5 minutes after the program start. After this time the child lock automatically activates.

## 10.12 Cancelling a running program

1. Press the  button for some seconds to cancel the program and to deactivate the appliance.



### Warning



If the appliance has already uploaded water, the door remains locked.

2. Press the same button again to activate the appliance. Now, you can set a new program.  
Before starting the new program the appliance could drain the water. In this case, make sure that the detergent is still in the detergent compartment, if not fill the detergent again.

## 10.13 At the end of the program

The appliance stops automatically. In the display,  comes on.



The indicator of the  button goes off.

The door unlocks.

1. Open the door.
2. Remove the laundry from the appliance. Make sure that the drum is empty.
3. Close the water tap.
4. Press the  button for some seconds to deactivate the appliance.  
Keep the door open to prevent the mildew and odours.

## 10.14 AUTO OFF option

The AUTO OFF option automatically deactivates the appliance to decrease the energy consumption when:

- You do not use the appliance for 5 minutes before you press the  button.  
Press the  button to activate the appliance again.
- After 5 minutes from the end of the program.  
Press the  button to activate the appliance again.  
The display shows the end of the last set program.  
Turn the program knob to set a new cycle.

## 11 Hints and tips



### Warning



Please refer to the "Safety information" sections.

### 11.1 The laundry load

- Divide the laundry in: white, coloured, synthetics, delicates and wool.
- Obey the washing instructions that are on the laundry care labels.
- Do not wash white and coloured items together.
- Some coloured items can discolour with the first wash. We recommend that you wash them separately for the first times.
- Turn multilayered fabrics, wool and items with painted illustrations inside out.
- Remove hard stains with a special detergent.
- Wash and pre-treat heavy soil stains with a suitable detergent before putting in drum.
- Be careful with the curtains. Remove the hooks and put the curtains in a washing bag or pillowcase.
- Do not wash laundry without hems or with cuts. Use a washing bag to wash small and/or delicate items (e.g. underwired bras, belts, tights, shoelaces, ribbons, etc. ).
- A very small load can cause balance problems with the spin phase leading to excessive vibration. If this occurs:
  - interrupt the program and open the door (please refer to the "Daily Use" section);
  - manually redistribute the load so that the items are spaced evenly around the tub;
  - press the "Start/Pause button". The spin phase continues.
- Button up pillowcases, close zippers, hooks and poppers. Tie up belts, cords, shoelaces, ribbons and any other loose elements.
- Empty the pockets and unfold the items.

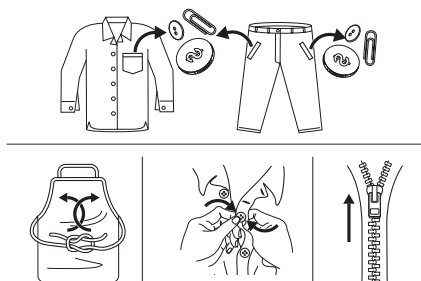

fig.X02963

### 11.2 Stubborn stains

For some stains, water and detergent is not sufficient.

We recommend that you pre-treat these stains before you put the items in the appliance.

Special stain removers are available. Use the special stain remover that is applicable to the type of stain and fabric.

Do not spray stain remover on garments near the appliance as it is corrosive to the plastic parts.



fig.X02964



### 11.3 Detergent type and quantity

The choice of detergent and use of correct quantities not only affects your wash performance, but also helps to avoid waste and protect the environment:

- Use only detergents and other treatments specially made for washer extractors. First, follow these generic rules:
  - powder detergents for all types of fabric, excluding delicate. Prefer powder detergents containing bleach for whites and laundry sanitization,
  - liquid detergents, preferably for low temperature wash programs (60 °C max) for all types of fabric, or special ones for woollens only.
- The choice and quantity of detergent will depend on: type of fabric (delicates, woollens, cottons, etc), the colour of clothes, size of the load, degree of soiling, wash temperature and hardness of the water used.
- Follow the instructions that you find on packaging of the detergents or other treatments without exceeding the indicated maximum level (**MAX**).
- Do not mix different types of detergents.
- Use less detergent if:
  - you are washing a small load,
  - the laundry is lightly soiled,
  - there is large amounts of foam during washing.
- When using detergent tabs or pods, always put them inside the drum, not in the detergent dispenser.

Insufficient detergent may cause:

- unsatisfactory washing results,
- the wash load to turn grey,
- greasy clothes,
- mould in the appliance.

Excessive detergent may cause:

- sudsing,
- reduced washing effect,
- inadequate rinsing,
- a greater impact for the environment.

### 11.4 Ecological hints

To save water, energy and to help protect the environment, we recommend that you follow these tips:

- Normally soiled laundry may be washed without prewash in order to save detergent, water and time.
- Loading the appliance to the maximum capacity indicated for each programs helps to reduce energy and water consumption.
- With adequate pre-treatment, stains and limited soiling can be removed; the laundry can then be washed at a lower temperature.
- To use the correct quantity of detergent, refer to the quantity suggested by the detergent producer and check the water hardness of your domestic system. Please refer to the "Water hardness" section.
- Set the maximum possible spin speed for the selected program before drying your laundry in a tumble dryer. This will save energy during drying.

### 11.5 Water hardness

If the water hardness in your area is high or moderate, we recommend that you use a water softener for washer extractors. In areas where the water hardness is soft it is not necessary to use a water softener.

To know the water hardness in your area, contact your local water authority.

Use the correct quantity of the water softener. Obey the instructions that you find on the packaging of the product.

## 12 Care and cleaning



### Warning



Please refer to the “Safety information” sections.

### 12.1 Periodic cleaning schedule

Periodic cleaning helps to extend the life of your appliance.

After each cycle, keep the door and the detergent dispenser slightly open to get air circulation and dry the humidity inside the appliance: this will prevent mildew and odours.

If the appliance is not used for a long time: close the water tap and unplug the appliance.

Periodic cleaning schedule:

Descaling	Twice a year
Maintenance wash	Once a month
Clean door seal	Every two months
Clean drum	Every two months
Clean detergent dispenser	Every two months
Clean the inlet hose and the valve filter	Twice a year

### 12.2 Removing foreign objects

Make sure that pockets are empty and all loose elements are tied up before running your cycle. Please refer to “The laundry load” section in “Hints and tips” section.

### 12.3 External cleaning

Clean the appliance with soap and warm water only. Fully dry all the surfaces. Do not use a scouring pads or any scratching material.



### Caution



Do not use alcohol, solvents or chemical products.



### Caution



Do not clean the metal surfaces with chlorine-based detergent.

### 12.4 Descaling

If the water hardness in your area is high or moderate, we recommend that you use a water descaling product for washer extractors.

Regularly examine the drum to prevent limescale and rust particles.

To remove rust particles use only special products for washer extractors. Do this separately from the laundry wash.

Always obey the instructions that you find on the packaging of the product.

### 12.5 Maintenance wash

With the low temperature programs it is possible that some detergent stays in the drum. Perform a maintenance wash regularly. To do this:

- Remove all laundry from the drum.
- Select the cotton program with the highest temperature without detergent.

## 12.6 Door seal

Regularly examine the seal and remove all objects from the inner part.

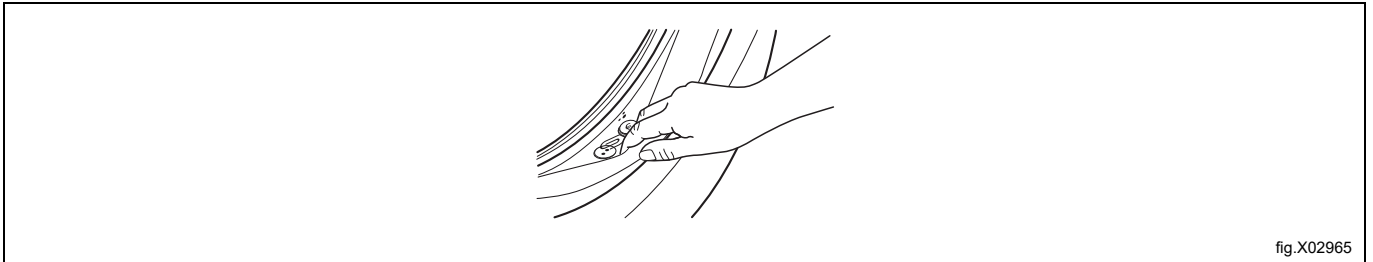

fig.X02965

## 12.7 Cleaning the drum

Regularly examine the drum to prevent limescale and rust particles. Only use special products to remove rust particles from the drum.

We suggest you to:

1. Clean the drum with special product for stainless steel.
2. Start a short program for cotton at the maximum temperature with a small quantity of detergent.

## 12.8 Cleaning the detergent dispenser

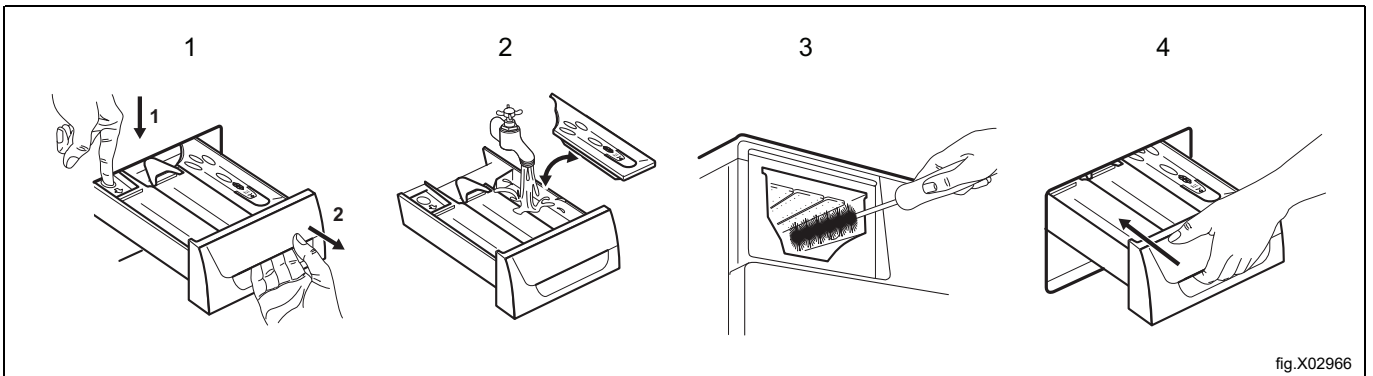

fig.X02966

## 12.9 Cleaning the drain filter

Do not clean the drain filter if the water in the appliance is hot.

Regularly check the drain pump filter and make sure that it is clean.

Repeat the steps 2 and 3 until the water stops flowing out.

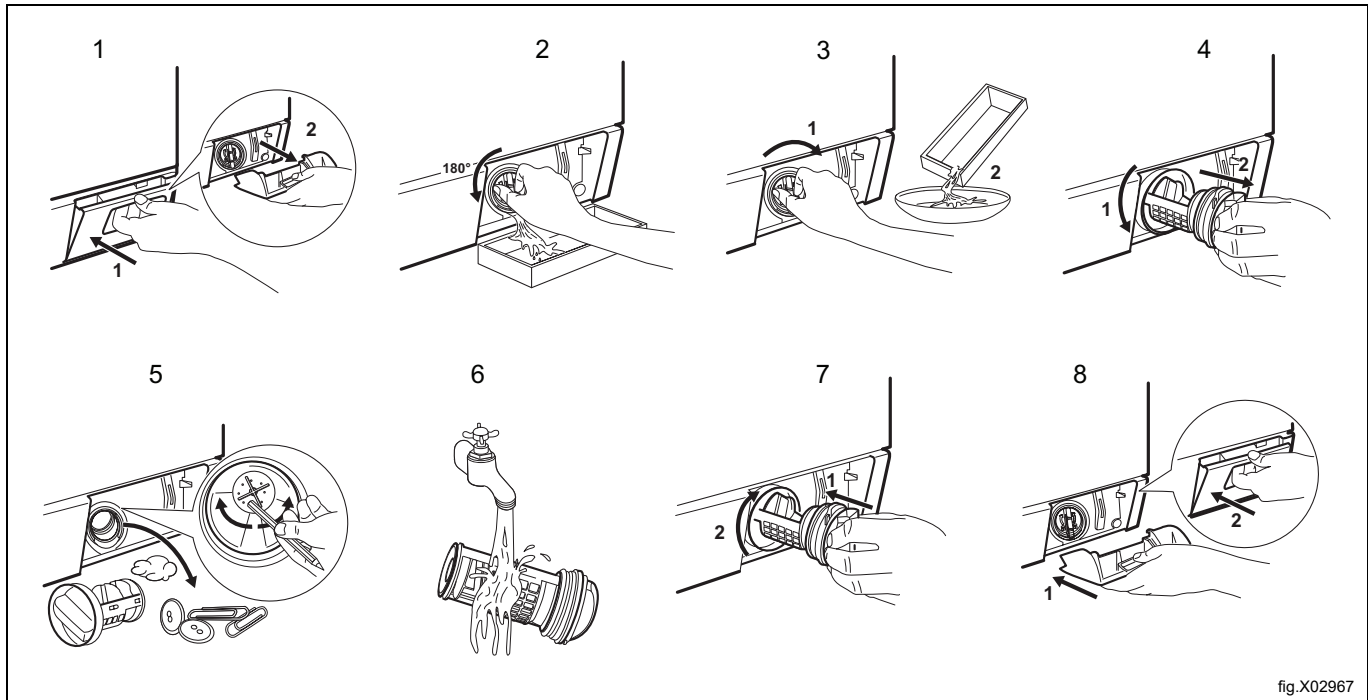

## 12.10 Cleaning the inlet hoses and the valve filters

Clean regularly both (for hot and for cold water) inlet hoses and both valve filters.

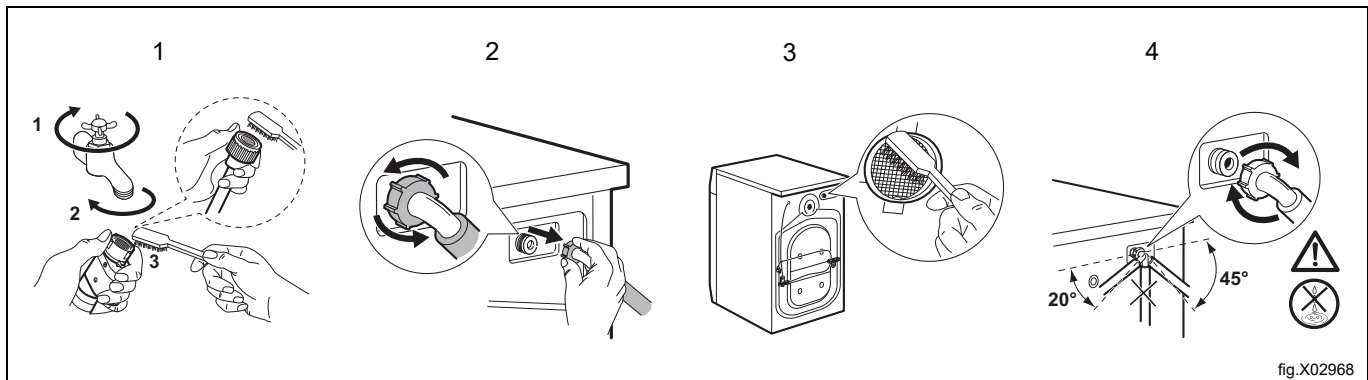

## 12.11 Emergency drain

Because of a malfunction, the appliance cannot drain the water.

If this occurs, do steps 1–9 of the “Cleaning the drain filter” section. If necessary, clean the pump.

When you drain the water with the emergency drain procedure, you must activate the drain system again:

1. Put 2 litres of water in the main wash compartment of the detergent dispenser.
2. Start the program to drain the water.

### 12.12 Frost precautions

If the appliance is installed in an area where the temperature can be less than 0°C, remove the remaining water from the inlet hose and the drain pump.

1. Disconnect the mains plug from the mains socket.
2. Close the water tap.
3. Put the two ends of the inlet hose in a container and let the water flow out of the hose.
4. Empty the drain pump. Please refer to the "Emergency drain" section.
5. When the drain pump is empty, install the inlet hose again.



#### Warning



Make sure that the temperature is more than 0°C before you use the appliance again.  
The manufacturer is not responsible for damages caused by low temperatures.

## 13 Trouble shooting



### Warning



Please refer to the “Safety information” sections.

### 13.1 Alarm Codes and Possible failures

If the appliance does not start or it stops during operation; first try to find a solution to the problem (refer to the following tables). If the problem continues, contact the Authorized Service Centre.



### Warning



Deactivate the appliance before carrying out any check.

With some problems, the display shows an alarm code and the  button may flash continuously:

Problem	Possible solution
<b>E 10</b> The appliance does not fill with water properly	<ul style="list-style-type: none"> <li>• Make sure that the water tap is open.</li> <li>• Make sure that the pressure of the water supply is not too low. For this information, contact your local water authority.</li> <li>• Make sure that the water tap is not clogged.</li> <li>• Make sure that the filters of the inlet hoses and the filters of the valves are not clogged. Please refer to the “Care and cleaning” section.</li> <li>• Make sure that the water inlet hoses has no kinks, damages or bends.</li> <li>• Make sure that the connections of the water inlet hoses are correct.</li> </ul>
<b>E20</b> The appliance does not drain the water	<ul style="list-style-type: none"> <li>• Make sure that the sink spigot is not clogged.</li> <li>• Make sure that the drain hose has no kinks or bends.</li> <li>• Make sure that the drain filter is not clogged. Clean the filter, if necessary. Please refer to the “Care and cleaning” section.</li> <li>• Make sure that the connection of the drain hose is correct.</li> <li>• Set the drain program if you set an option which ends with water in the tub.</li> </ul>
<b>E40</b> The appliance door is open or not closed correctly	<ul style="list-style-type: none"> <li>• Make sure that the door is properly closed.</li> </ul>
<b>E91</b> Internal fail. No communication between electronic elements of the appliance	<ul style="list-style-type: none"> <li>• The program was not finished properly or the appliance stopped too early. Switch the appliance off and on again.</li> <li>• If the alarm code appears again, contact the Authorized Service Centre.</li> </ul>
<b>E40</b> The mains supply is unstable	<ul style="list-style-type: none"> <li>• Wait until mains supply is stable.</li> </ul>

If the display shows other alarm codes, deactivate and activate the appliance. If the problem continues, contact the Authorized Service Centre.

In case of different problem with the washer extractor check the table below for possible solutions.

Problem	Possible solution
The program does not start	<ul style="list-style-type: none"> <li>• Make sure that the mains plug is connected to the mains socket.</li> <li>• Make sure that the appliance door is closed.</li> <li>• Make sure that there is no damaged fuse in the fuse box.</li> <li>• Make sure that the  has been touched.</li> <li>• If the delay start is set, cancel the setting or wait for the end of countdown.</li> <li>• Deactivate the Child Lock function if it is on.</li> <li>• Check the position of the knob on the selected program.</li> </ul>
The appliance fills with water and drains immediately	<ul style="list-style-type: none"> <li>• Make sure that the drain hose is in the correct position. The hose may be positioned too low. Please refer to "Installation instruction".</li> </ul>
The spin phase does not operate or the washing cycle lasts longer than usual	<ul style="list-style-type: none"> <li>• Make sure that the drain filter is not clogged. Clean the filter, if necessary. Please refer to the "Care and cleaning" section.</li> <li>• Adjust manually the items in the tub and start the spin phase again. This problem may be caused by balance problems.</li> </ul>
There is water on the floor	<ul style="list-style-type: none"> <li>• Make sure that the couplings of the water hoses are tight and there is not water leakages.</li> <li>• Make sure that the water inlet hose and the drain hose have no damages.</li> <li>• Make sure you use the correct detergent and the correct quantity of it.</li> <li>• Too much detergent or unsuitable detergent creates too much foam. Reduce detergent quantity and/or use a suitable detergent.</li> </ul>
You cannot open the appliance door	<ul style="list-style-type: none"> <li>• Make sure that a program that ends with water in tub, has not been selected.</li> <li>• Make sure that the program is finished.</li> </ul>
The appliance makes an unusual noise and vibrates	<ul style="list-style-type: none"> <li>• Make sure the levelling of the appliance is correct. Please refer to "Installation instruction".</li> <li>• Make sure that the packaging and/or the transit bolts are removed. Please refer to "Installation instruction".</li> <li>• Add more laundry in the drum. The load may be too small.</li> </ul>
The cycle is shorter than the time displayed	<ul style="list-style-type: none"> <li>• The appliance calculates a new time according to the laundry load.</li> </ul>
The washing results are not satisfactory	<ul style="list-style-type: none"> <li>• Increase the detergent quantity or use a different detergent.</li> <li>• Use special products to remove the stubborn stains before you wash the laundry.</li> <li>• Make sure that you set the correct temperature.</li> <li>• Decrease the laundry load.</li> </ul>
Too much foam in the drum during the washing cycle	<ul style="list-style-type: none"> <li>• Reduce the quantity of detergent.</li> <li>• Too much detergent or unsuitable detergent has been used. Reduce detergent quantity and/or use a correct detergent.</li> </ul>
After the washing cycle, there are some detergent residues in the detergent dispenser	<ul style="list-style-type: none"> <li>• Make sure that the flap is in the correct position (UP for powder detergent - DOWN for liquid detergent).</li> <li>• Make sure you have used the detergent dispenser according the indications given in this user manual.</li> </ul>
The drum light does not go on	<ul style="list-style-type: none"> <li>• Make sure that the LED lamp is not burned. To replace it, contact the Authorized Service Centre.</li> </ul>

After the check, activate the appliance. The program continues from the point of interruption.



If the problem occurs again, contact the Authorized Service Centre.

The necessary data for the service centre are on the rating plate.

## 14 Emergency door opening

In case of power failure or appliance failure the appliance door remains locked. The program continues, when the power is restored. If the door remains locked in case of failure, it is possible to open it using the emergency unlock feature.

Before opening the door:

	<b>Caution</b>	
Make sure that the water temperature and the laundry are not hot. Wait until they cool down, if necessary.		

	<b>Caution</b>	
Make sure that the drum is not rotating. Wait until the drum stops rotating, if necessary.		

Make sure that the water level inside the drum is not too high. Proceed with an emergency drain, if necessary. Please refer to the "Emergency drain" section in the "Care and cleaning" section).

To open the door, proceed as follows:

1. Press the  button to switch the appliance off.
2. Disconnect the mains plug from the mains socket.
3. Open the filter flap.
4. Pull the emergency unlock trigger downward once. Pull it downward once again, keep it tensed and, at the same time, open the appliance door.

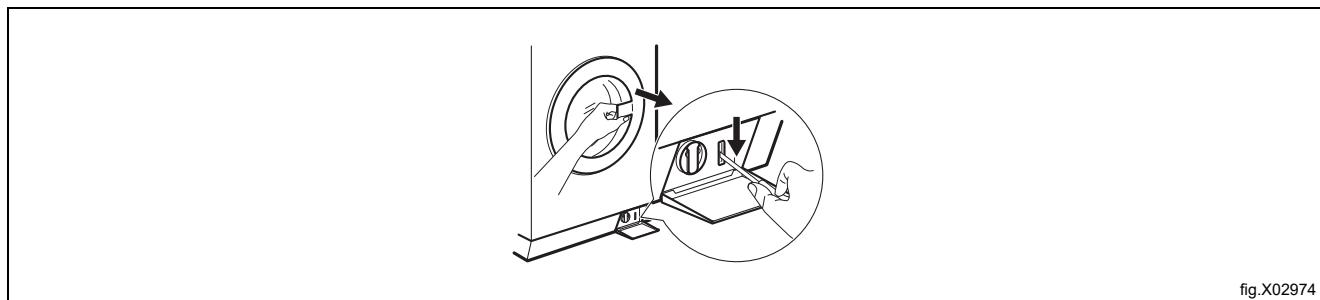

fig.X02974

5. Take out the laundry and then close the appliance door.
6. Close the filter flap.



## 15 Technical data

Dimension	Width x Height x Total depth	59.7 cm / 84.7 cm / 64.6 cm
Electrical connection	Voltage	220 - 240V
	Overall power	2200 W
	Fuse	10 A
	Frequency	50 Hz
Level of protection against ingress of solid particles and moisture ensured by the protective cover, except where the low voltage equipment has no protection against moisture		IPX4
Water supply pressure	Minimum	0.5 bar (0.05 MPa)
	Maximum	10 bar (1.0 MPa)
Water supply <sup>1</sup>	Cold water	
	Hot water <sup>2</sup>	
Maximum Load	Cotton	8.0 kg
Spin Speed	Maximum spin speed	1351 rpm

1. Connect the water inlet hoses to a water tap with a 3/4" thread.

2. Make sure that the hot water temperature of your domestic system is not higher than 60 °C.

The appliance also works by connecting only the cold water pipe.

### 15.1 Electrical connection

At the end of installation you can connect the mains plug to the mains socket.

The rating plate and the Technical Data section indicate the necessary electrical ratings. Make sure that they are compatible with the mains power supply.

Check that your domestic electrical installation can take the maximum load required, also taking into account any other appliances in use.

Connect the appliance to an earthed socket.

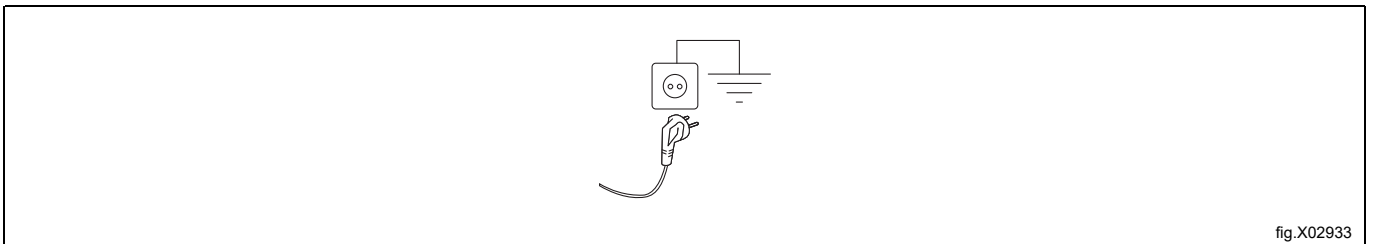

fig.X02933

The power supply cable must be easily accessible after installing the appliance.

For any electrical work required to install this appliance, contact our Authorized Service Centre.

The manufacturer does not accept any responsibility for damage or injury through failure to comply with the above safety precaution.

## 16 Disposal information

### 16.1 Disposal of appliance at end of life

Before disposing of the machine, make sure to carefully check its physical condition, and in particular any parts of the structure that can give or break during scrapping.

The machine's parts must be disposed of in a differentiated way, according to their different characteristics (e.g. metals, oils, greases, plastic, rubber, etc.).

Different regulations are in force in the various countries, therefore comply with the provisions of the laws and competent bodies in the country where scrapping takes place.

In general, the appliance must be taken to a specialised collection/scrapping centre.

Dismantle the appliance, grouping the components according to their chemical characteristics, remembering that the compressor contains lubricant oil and refrigerant fluid which can be recycled, and that the refrigerator and heat pump components are special waste assimilable with urban waste.

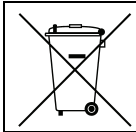

The symbol on the product indicates that this product should not be treated as domestic waste, but must be correctly disposed of in order to prevent any negative consequences for the environment and human health. For further information on the recycling of this product, contact the local dealer or agent, the Customer Care service or the local body responsible for waste disposal.



#### Note!

**When scrapping the machine, any marking, this manual and other documents concerning the appliance must be destroyed.**

### 16.2 Disposal of packing

The packing must be disposed of in compliance with the current regulations in the country where the appliance is used. All the packing materials are environmentally friendly.

They can be safely kept, recycled or burned in an appropriate waste incineration plant. Recyclable plastic parts are marked as following examples.

	Polyethylene: <ul style="list-style-type: none"> <li>• Outer wrapping</li> <li>• Instructions bag</li> </ul>
	Polypropylene: <ul style="list-style-type: none"> <li>• Straps</li> </ul>
	Polystyrene foam: <ul style="list-style-type: none"> <li>• Corner protectors</li> </ul>





Electrolux Professional AB  
341 80 Ljungby, Sweden  
[www.electroluxprofessional.com](http://www.electroluxprofessional.com)